

DSE3J

DIRECTIONAL VALVE WITH PROPORTIONAL CONTROL FEEDBACK AND INTEGRATED ELECTRONICS

SERIES 20

SUBPLATE MOUNTING
ISO 4401-03 (CETOP 03)

p max 350 bar
Q max 80 l/min

MOUNTING SURFACE

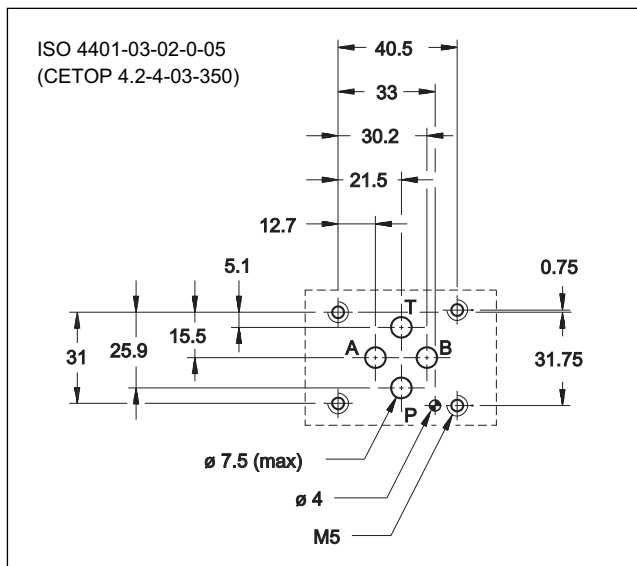

OPERATING PRINCIPLE

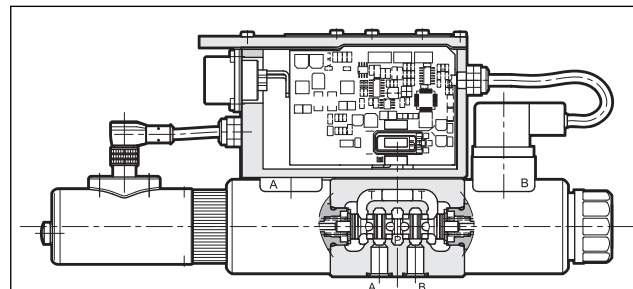

- The DSE3J is a direct operated directional valve with integrated electric proportional control, feedback and mounting interface in compliance with ISO 4401 (CETOP RP 121H) standards.
- The valve opening and hence flow rate can be modulated continuously in proportion to the reference signal. Transducer and digital card allow a fine control of the positioning of the cursor, reducing hysteresis and response time and optimizing the performance of the valve.

— It is available with fail safe function.

- The valve is easy to install. The driver directly manages digital settings (see par. 6). For special applications, it's possible to customize the settings using the optional kit (see at paragraph 7).

PERFORMANCES (Obtained with mineral oil with viscosity of 36 cSt at 50°C and with digital integrated electronic)

Max operating pressure: - P - A - B ports - T port	bar	350 210
Nominal flow with Δp 10 bar P-T	l/min	4 - 12 - 30
Response times	see paragraph 4	
Hysteresis	% of Q_{max}	< 0,2%
Repeatability	% of Q_{max}	< 0,2%
Threshold		< 0,1%
Valve reproducibility		$\leq 5\%$
Electrical characteristics, IP	see paragraph 5	
Ambient temperature range	°C	-20 / +60
Fluid temperature range	°C	-20 / +80
Fluid viscosity range	cSt	10 + 400
Fluid contamination degree	according to ISO 4406:1999 class 18/16/13	
Recommended viscosity	cSt	25
Mass: single solenoid valve double solenoid valve	kg	2,2 2,7

HYDRAULIC SYMBOLS (typical)

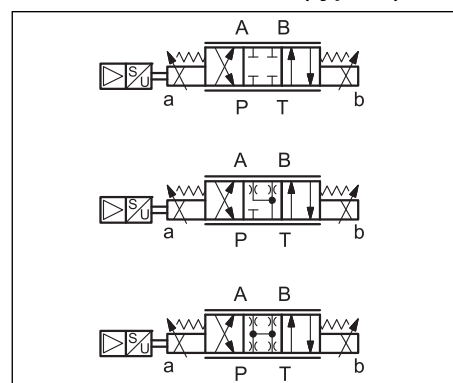

3 - CHARACTERISTIC CURVES (obtained with mineral oil with viscosity of 36 cSt at 50°C and with digital integrated electronics)

Typical flow rate curves at constant Δp related to the reference signal and measured for the available spools. The Δp values are measured between P and T valve ports.

The curves are obtained after linearization in factory of the characteristic curve through the digital amplifier.

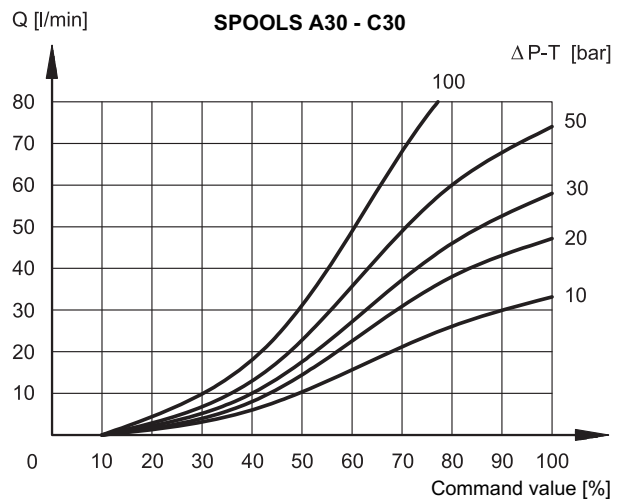
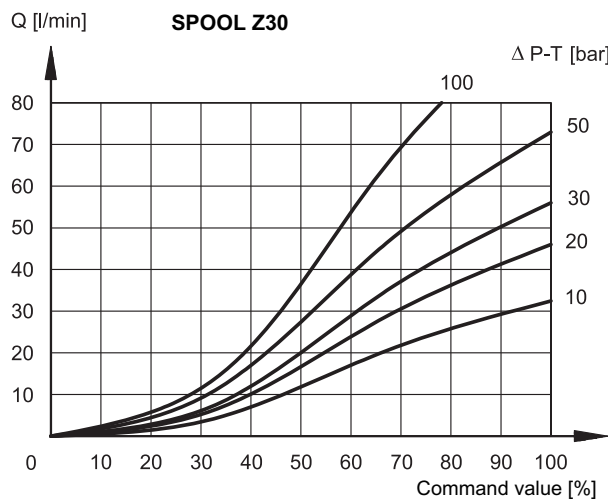
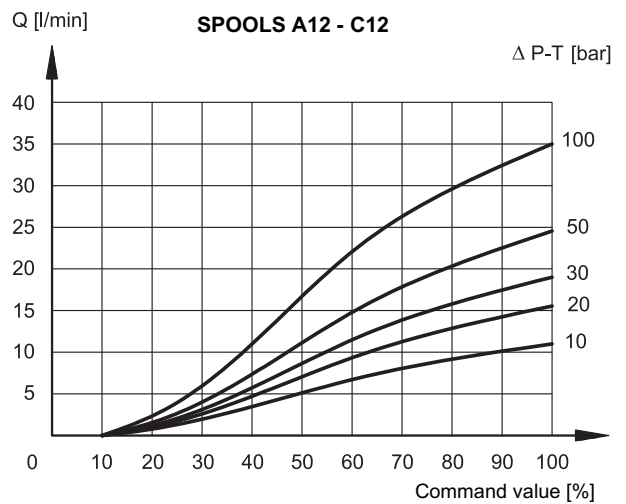
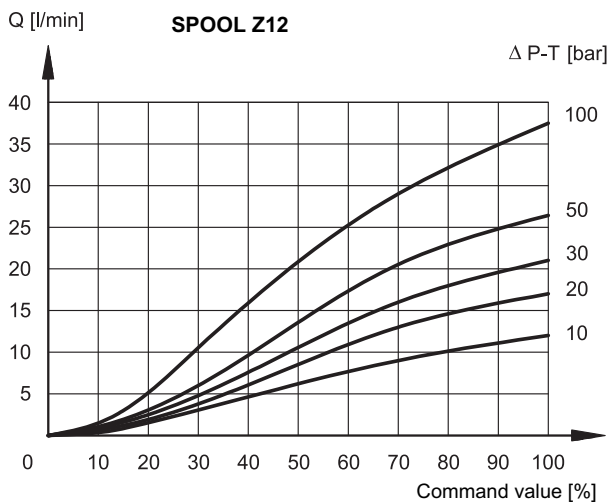
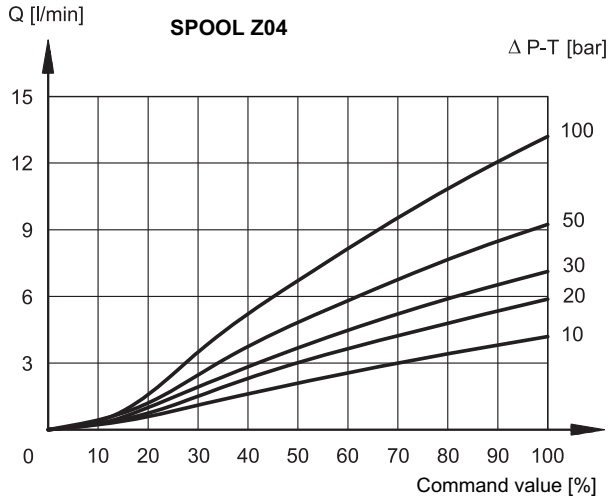
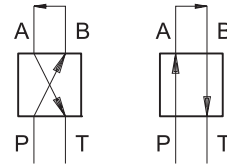

Z SPOOLS - PRESSURE GAIN

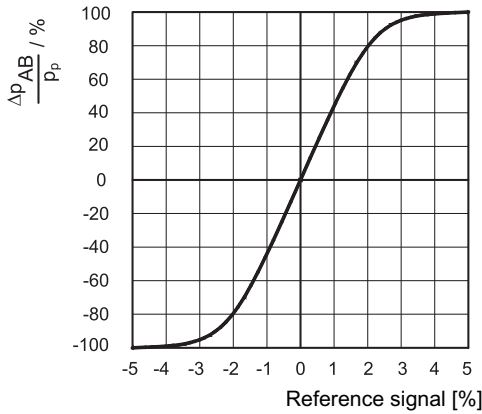

The diagram shows the valve pressure gain, expressed as % of the ratio between the port pressure variation in A or B (Δp_{AB}) and the P system pressure, according to the reference signal.

In practice, the pressure gain states the valve reaction towards external disturbances aimed at changing the actuator position.

Z*FS SPOOLS - FAIL SAFE FEATURE

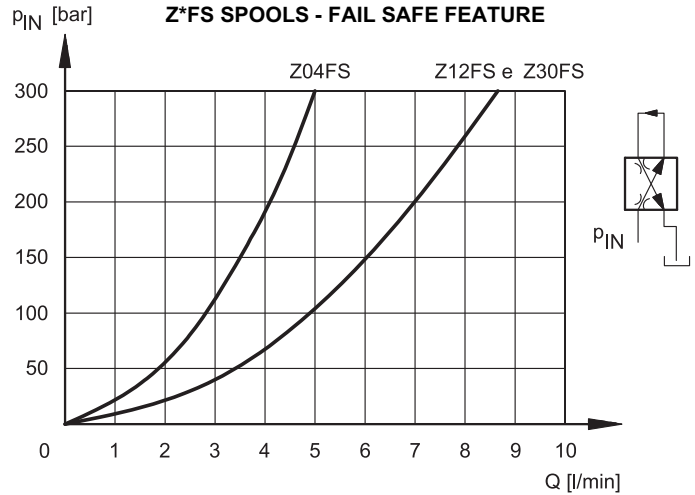

Flow $P \rightarrow B / A \rightarrow T$ with valve in fail safe position, depending on the incoming pressure.

When a power failure (enabling OFF) occurs, the valve moves in 'fail safe' position by maintaining a minimum flow that allows the actuator to return slowly to a safety position.

During the black-out the centering springs retain the spool in fail safe-position.

4 - RESPONSE TIME (obtained with mineral oil with viscosity of 36 cSt at 50°C and with digital integrated electronics and Δp (P-T) 10 bar)

FREQUENCY RESPONSE (SPOOL Z)

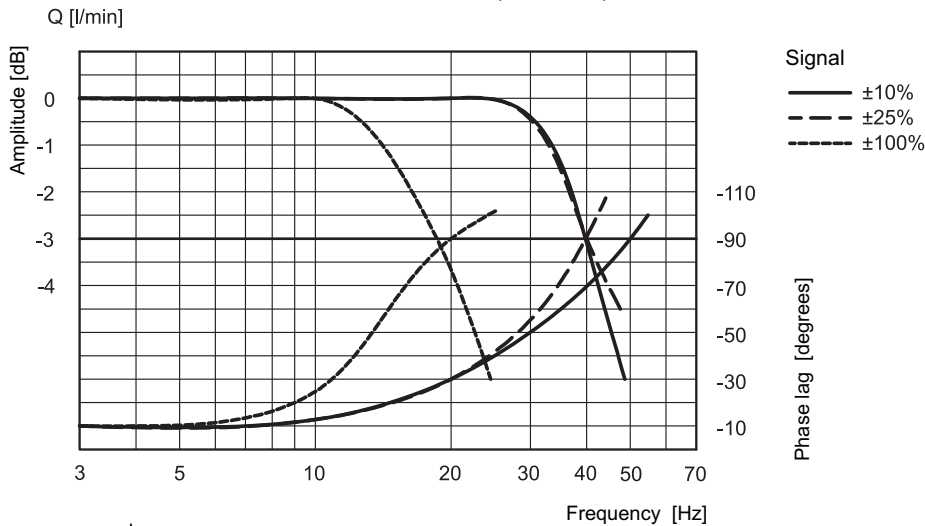

RESPONSE TIME

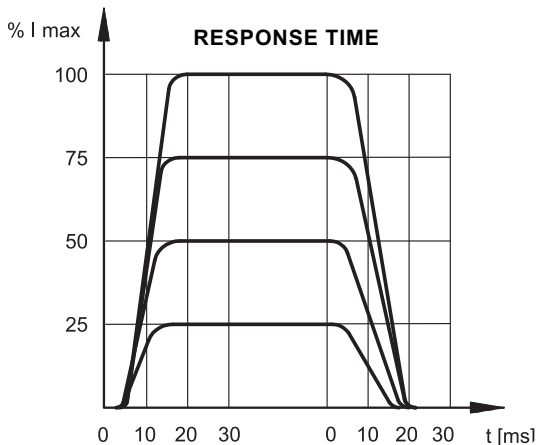

5 - ELECTRICAL CHARACTERISTICS

5.1 - Digital integrated electronics

The proportional valve is controlled by a digital amplifier (driver), which incorporates a microprocessor that controls, via software, all the valve functions, such as:

- continuous converting of the voltage reference signal (E0) or of the current reference signal (E1) in a digital value
- generation of up and down ramps
- gains limit
- compensation of the dead band
- protection of the solenoid outputs against possible short circuits

The digital driver enables the valve to reach better performances compared to the analogic version, such as:

- reduced response times
- optimization and reproducibility of the characteristic curve, optimised in factory for each valve
- complete interchangeability in case of valve replacement
- possibility to set, via software, the functional parameters
- possibility to perform a diagnostic program by means of the LIN connection
- high immunity to electromagnetic troubles

We deliver the DSE3J with these standard settings:

UP/DOWN ramp at minimum value, no deadband compensation, max valve opening (100% of spool stroke). It is possible to customize these parameters using the special kit, to be ordered separately (see par 7).

5.2 - Functional block diagram

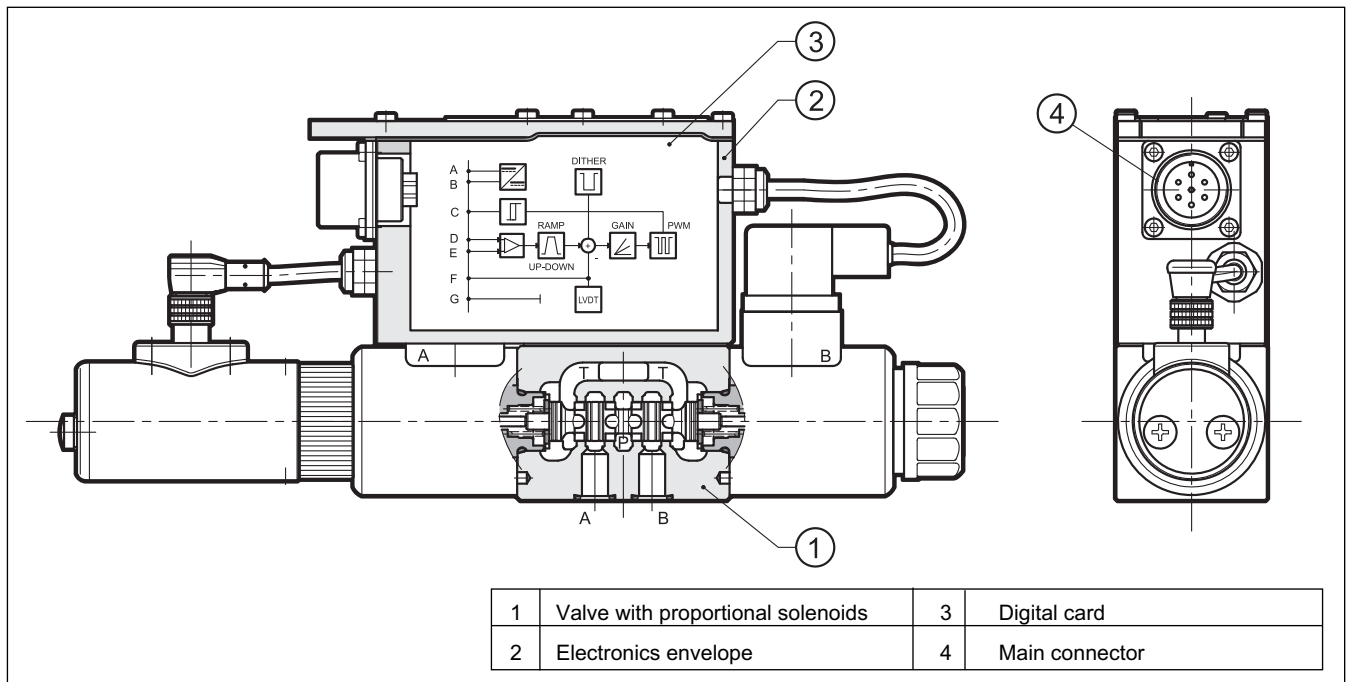

5.3 - Electrical characteristics

NOMINAL VOLTAGE	V DC	24 (from 19 to 35 VDC, ripple max 3 Vpp) external fuse 5A (fast), max current 3A
ABSORBED POWER	W	70
MAXIMUM CURRENT	A	2.6
DUTY CYCLE		100%
VOLTAGE SIGNAL (E0)	V DC	±10 (Impedance Ri > 50KΩ)
CURRENT SIGNAL (E1)	mA	4 ÷ 20 (Impedance Ri = 500 Ω)
ALARMS		Overload and electronics overheating, LVDT sensor error, cable breakdown or power failure or < 4mA.
COMMUNICATION		LIN-bus Interface (with the optional kit)
MAIN CONNECTOR		7 - pin MIL-C-5015-G (DIN 43563)
ELECTROMAGNETIC COMPATIBILITY (EMC) emissions immunity	CEI EN 61000-6-4 CEI EN 61000-6-2	According to 2004/108/CE standards
PROTECTION AGAINST ATMOSPHERIC AGENTS		IP65 / IP67 (CEI EN 60529 standards)

6 - OPERATING MODALITIES

The digital driver of DSE3J valve is available in two versions, with voltage or current reference signal.

6.1 - Version with voltage reference signal (E0)

This is the most common version; it makes the valve completely interchangeable with the traditional proportional valves with analogic type integrated electronics. The valve has only to be connected as indicated below. This version doesn't allow the setting of the valve parameters, for example the ramps must be performed in the PLC program, as well as the reference signal limit.

Connection scheme E0

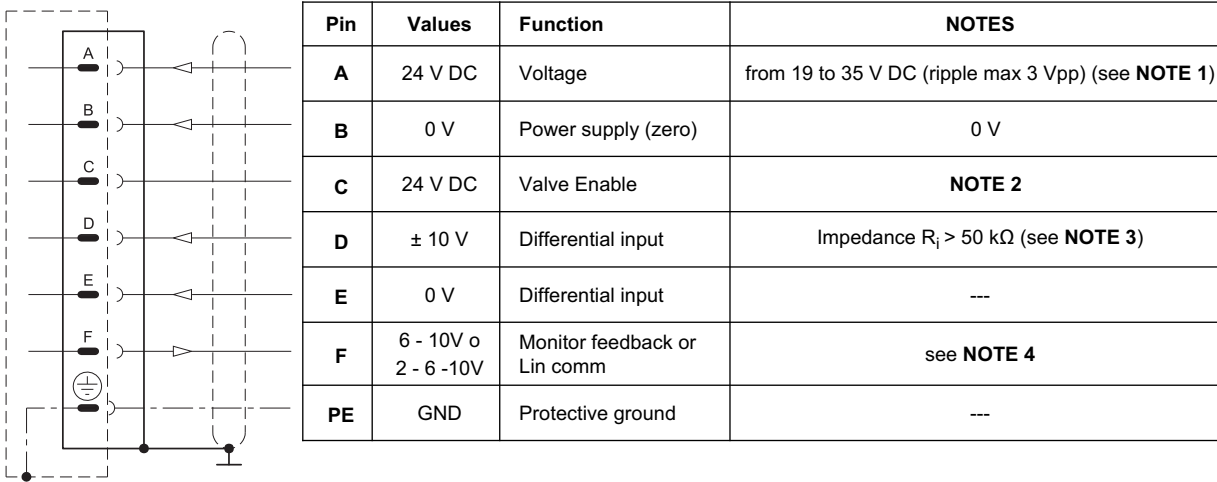

6.2 - Version with current reference signal (E1)

The reference signal is supplied in current 4 - 20 mA. With the 12 mA signal the valve is in central position, with the 20 mA signal the valve performs the configuration P-A and B-T, while with 4 mA the configuration is P-B and A-T. For "SA" single solenoid valves, with reference 20 mA to pin D, the valve full opening is P-B and A-T, while with 4 mA the valve is at rest. If the current to solenoid is lower, than the card shows a BREAKDOWN CABLE error. To reset the error is sufficient to restore the current 4mA.

Connection scheme E1

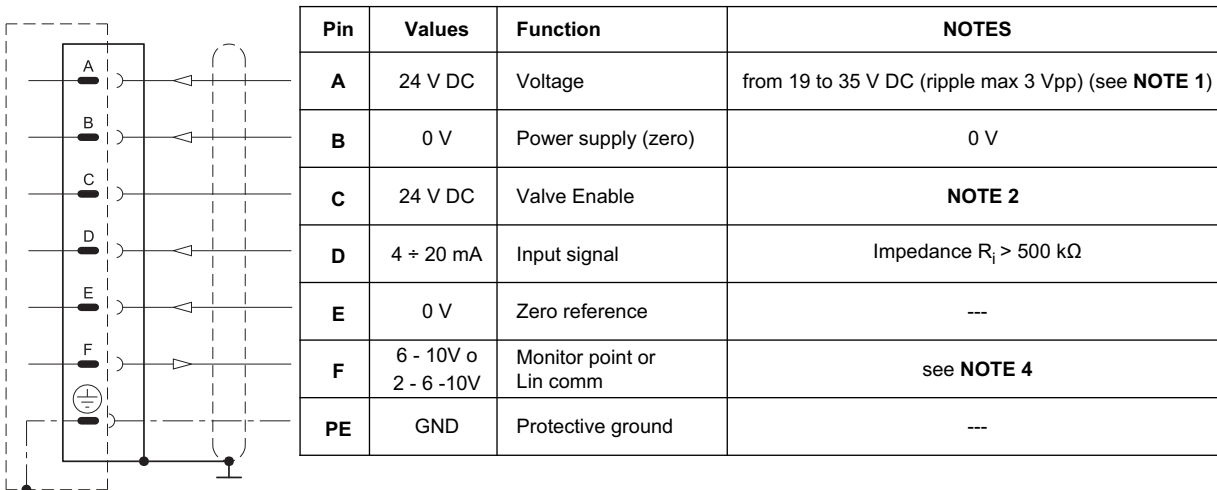

NOTE 1: preview on the Pin A (24 VDC) an external fuse for protecting electronics. Fuse characteristics: 5A/50V type fast.

NOTE 2: preview 24V DC on the PIN C to activate the card power stage.

NOTE 3: The input signal is differential type on E0 version only. For double solenoid valves, with positive reference signal connected to pin D, the valve opening is P - A and B - T. With zero reference signal the valve is in central position. For "SA" single solenoid valves, with positive reference to pin D, the valve opening is P-B and A-T. The spool stroke is proportional to $U_D - U_E$.

If only one input signal (single-end) is available, the pin B (0V power supply) and the pin E (0V reference signal) must be connected through a jumper and both connected to GND, electric panel side.

NOTE 4: This value changes, as shown in the table below. When MONITOR function is enabled and the card is enabled, read the test point pin F in relation to pin B (0V). When detect a failure or error of the sensor LVDT, the drive bring the valve back in central position and locks it. In this condition the pin F, referring to the pin B, indicates 0V DC output. To reset the fault, the card must be disabled and re-enable. When the card is disabled, the pin F referred to the pin B shows 2.7V DC output: this value is given by the voltage of the LIN bus communication and not by the MONITOR value.

double solenoid valves		single solenoid valve	
command (Pin D)	Pin F	command (Pin D)	Pin F
-10 V	10 V	-	-
0 V	6 V	0 V	6 V
+10 V	2 V	+10 V	10 V

NOTE for the wiring: connections must be made via the 7-pin plug mounted on the amplifier. Recommended cable sizes are 0,75 mm² for cables up to 20m and 1,00 mm² for cables up to 40m, for power supply. The signal cables must be 0,50 mm². A suitable cable would have 7 cores, a separate screen for the signal wires and an overall screen.

7 - OPTIONAL KIT LINPC-USB/10

The kit (to be ordered separately, code 3898501001) includes control box with 7 poles connector, USB PC cable (1.8 m length), software for card configuration. The software is Microsoft XP® compliant.

The box has three main functions:

- It can be used to read the values from the external command (PLC, etc. ...) to the valve. In this case, the box simply acts as monitor through points of measurement.
- It may exclude the command from the PLC and controls the valve, choosing the direction and speed of movement (keys gr.2 and 4). This way you can test the response of the valve control input, and diagnose failures, malfunctions, simulating the valve working.
- The control box acts as interface between PC and electronic card (key 3) to allow customization of the parameters via software.

For more detailed information on the use of the box, see the documentation on the software CD.

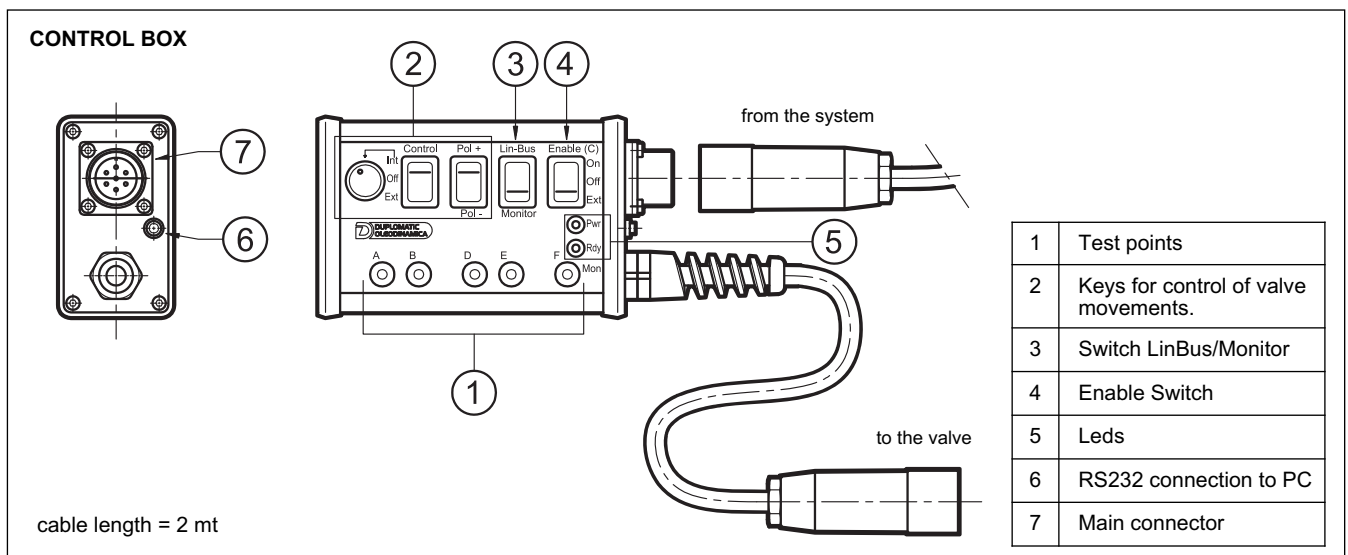

7.1 - Programming the parameters via LIN Bus

The software included in the kit allows the customization of the following parameters:

Deadband compensation

You can change the mechanical spool overlap by adjusting the parameters V: MINA and V MINB.

Gain Adjustment

You can change the parameters V and V MAXA: MAXB, which restrict the spool opening for positive and negative values of the reference signal.

AINW: W command input scaling

This command allows to scale the input signal and determine whether the input is enabled for signals in voltage or in current.

V: TRIGGER

Value in percentage by which you activate the deadband function of V: MinA and V: minB

Ramps

Ramps are divided into four quadrants and can be customized by setting the parameters 1Q, 2Q, 3Q and 4Q. They define the time variation of current in the solenoid in reference to input command. range: 1 ÷ 60000 ms.

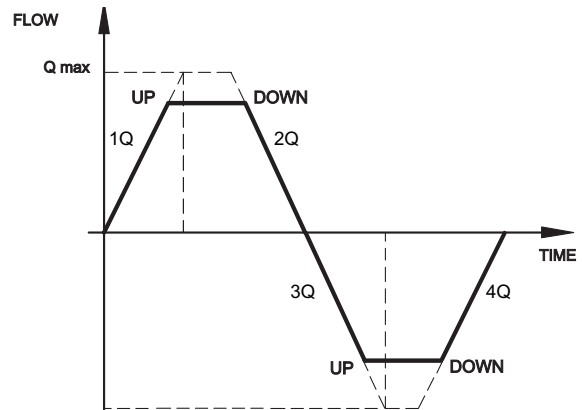

7.2 - Wiring scheme of Lin/Bus box

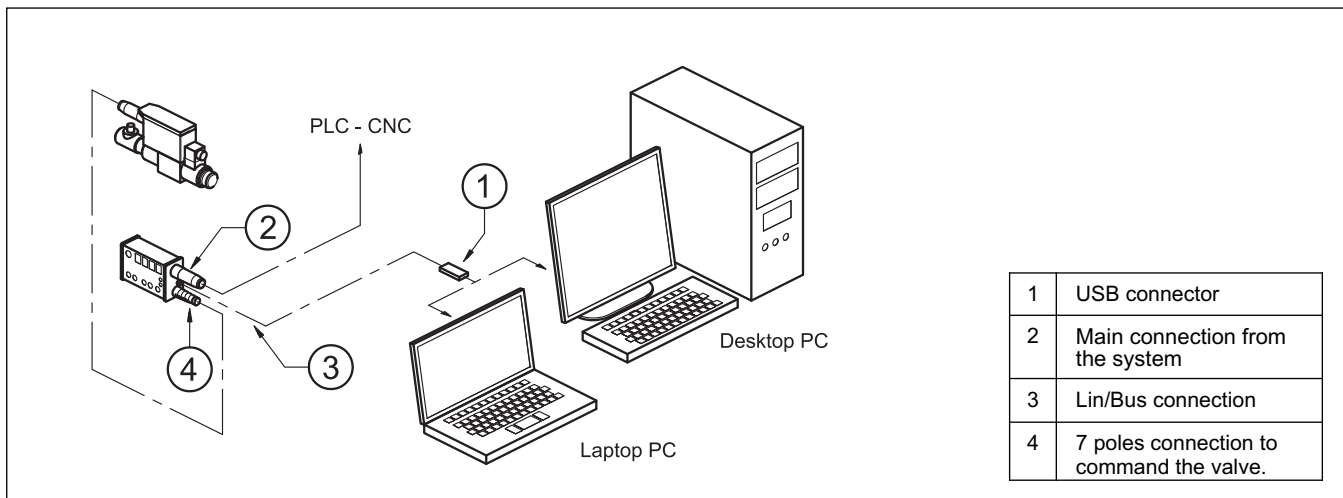

8 - HYDRAULIC FLUIDS

Use mineral oil-based hydraulic fluids HL or HM type, according to ISO 6743-4. For these fluids, use NBR seals. For fluids HFDR type (phosphate esters) use FPM seals (code V). For the use of other kinds of fluid such as HFA, HFB, HFC, please consult our technical department.

Using fluids at temperatures higher than 80 °C causes a faster degradation of the fluid and of the seals characteristics.

The fluid must be preserved in its physical and chemical characteristics.

9 - INSTALLATION

DSE3J valves can be installed in any position without impairing correct operation.

Ensure that there is no air in the hydraulic circuit.

Valves are fixed by means of screws or tie rods on a flat surface with planarity and roughness equal to or better than those indicated in the relative symbols. If minimum values are not observed, fluid can easily leak between the valve and support surface.

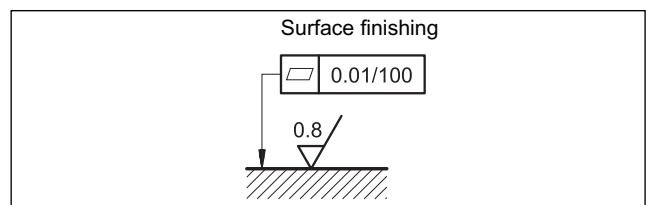

10 - OVERALL AND MOUNTING DIMENSIONS

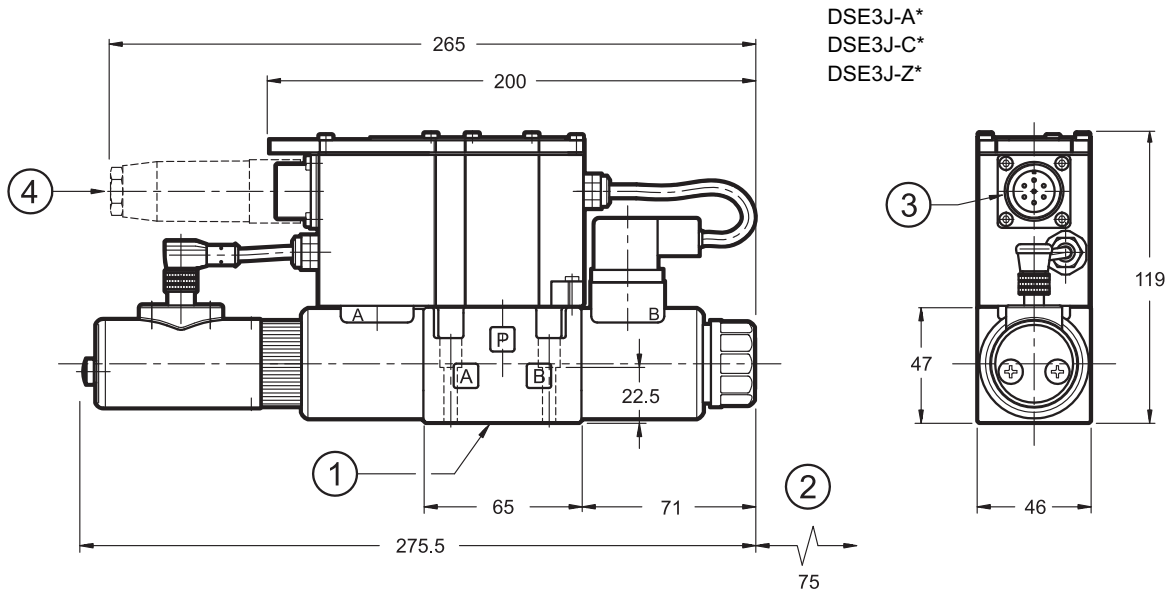

Adjustment sealing performed at factory.
Do not disassemble the transducer.

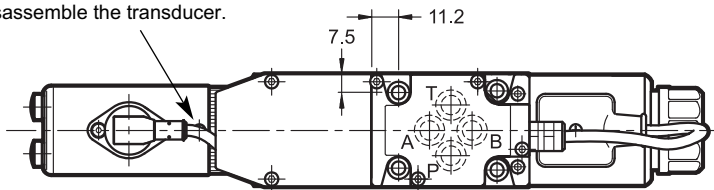

DSE3J-A* SA
DSE3J-C* SA

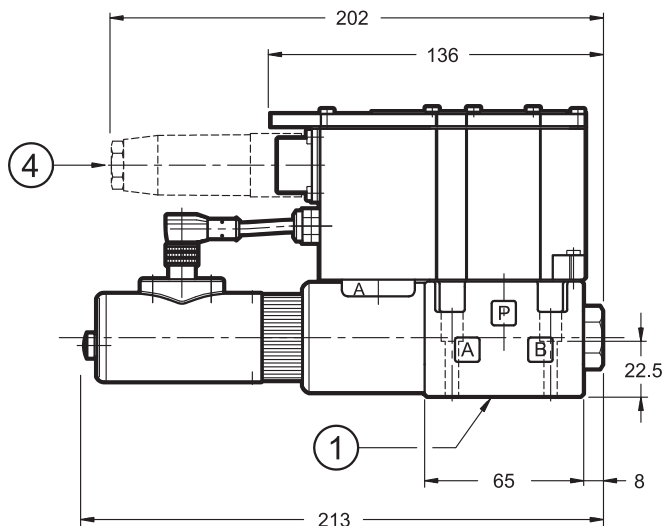

dimensions in mm

1	Mounting surface with sealing rings: 4 OR type 2037 (9.25 x 1.78) - 90 shore
2	Coil removal space (solenoid B only)
3	Main connection
4	Electrical connector 7 pin DIN 43563 IP67 PG11 EX7S/L/10 code 3890000003 (to be ordered separately)

Adjustment sealing performed at factory.
Do not disassemble the transducer.

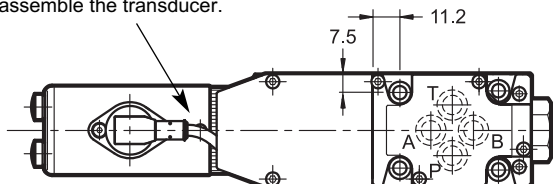

Fastening bolts: 4 bolts M5x30 - ISO 4762
Torque: 5 Nm



11 - SUBPLATES (see catalogue 51 000)

PMMD-AI3G rear ports
PMMD-AL3G side ports
Ports dimensions: P, T, A, B: 3/8" BSP



DIPLOMATiC OLEODiNAMiCA S.p.A.
20015 PARABIAGO (MI) • Via M. Re Depaolini 24
Tel. +39 0331.895.111
Fax +39 0331.895.339
www.diplomatic.com • e-mail: sales.exp@diplomatic.com

